

PAPER TOWEL DISPENSER, LOCKABLE WITH DRAWER FOR MOUNTING BEHIND FIXED MIRROR WP176-1



298 x 385 x 135 mm

approx. 500 paper towels

- Paper towel dispenser in robust, germ-reducing and easy-care stainless steel (AISI 304).
- For mounting behind fixed mirror on site.
- All-stainless steel housing; all corners fully welded, visible surfaces satin finished and brushed.
- With deep-drawn paper removal opening for easy paper removal.
- Designed for approx. 500 standard paper towels in zigzag fold.
Paper size (folded): 240-250 mm x 100-115 mm.
Accessible for refilling from the front through lockable drawer that can be pulled out downwards.
- Keyed alike cylinder lock in corrosion-resistant zinc die-casting.
- Wear parts can be replaced as modules.
- Mounting: With four screws.
Depth of substructure installation: min. 140 mm.
Height above vanity unit: min. 285 mm.
- Delivery includes fixing material, self-adhesive information label „Paper“ and one pack of paper towels.
- Weight, including single package: 5.3 kg

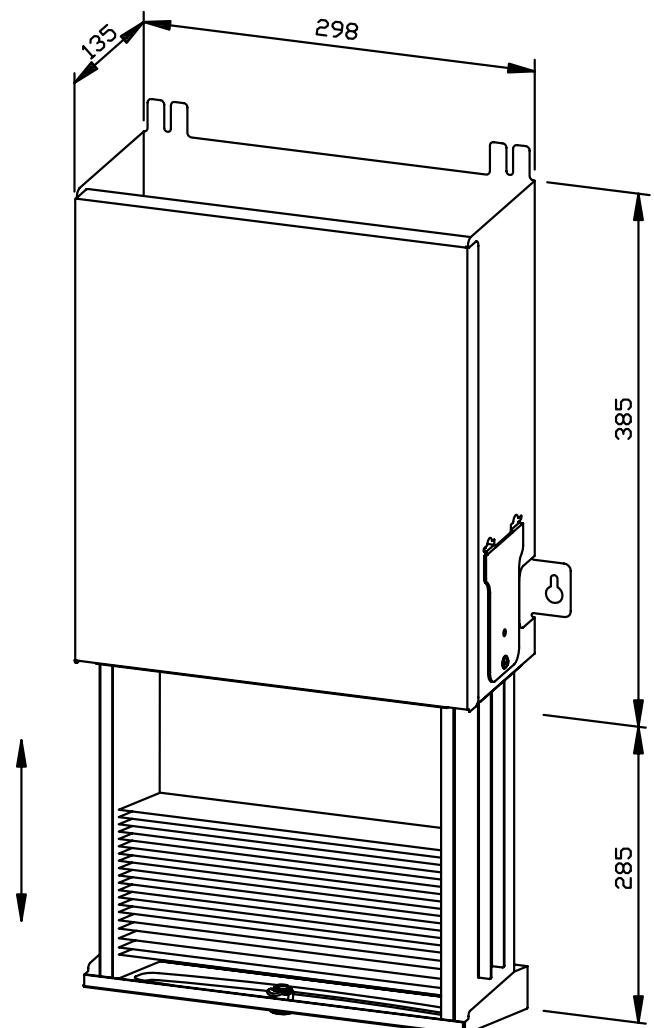

Suggested text for specifications:

Paper towel dispenser in stainless steel (AISI 304) for mounting behind fixed mirror. All-stainless steel housing; all corners fully welded, visible surfaces satin finished and brushed. With deep-drawn paper removal opening, filling quantity approx. 500 paper towels. Accessible for refilling from the front through lockable drawer that can be pulled out downwards. Keyed alike cylinder lock in corrosion-resistant zinc die-casting. Delivery includes fixing material, self-adhesive information label „Paper“ and one pack of paper towels.

Dimensions: 298 x 385 x 135 mm

Article No. WP176-1

Available surface	ID No.
satin finished	727 065

Ernst Wagner GmbH & Co. KG

Ernst-Abbe-Straße 21 · D-72770 Reutlingen · Tel.: +49712151539-0 · Fax: -20
info@wagner-ewar.de · www.wagner-ewar.de

WAGNER
EWAR